

BOM	
Item	Description
1	1.875" OD Peak
2	1.625" OD Truss
3	1.625" OD Arc
4	1.625" OD Post
5	2" x 2" Metal Framing
6	2'x2' Hot Air Vent
7	8'x8' Bay Door
8	1"x2" Roll-Up Board
9	Bay Door Bottom Header
10	1.375" OD Purlin
11	1.875" OD Swedge Post

Wind Load - 65 MPH  
 Snow Load - 30 PSF

UNLESS OTHERWISE SPECIFIED, DIMENSIONS ARE IN INCHES		NAME	DATE
.X = ±0.1	DRAWN	Rica Abing	08/29/2024
	CHECKED	Kevin Roberts	
	APPROVED		
BREAK ALL SHARP EDGES AND REMOVE BURRS			
THIRD ANGLE PROJECTION		MATERIAL	FINISH

Roberts Ranch Hoophouses			
TITLE 24' Wide Gothic Hightunnel Front View			
SIZE A	DWG NO. G24-1	REV. A	
SCALE 1:40	WEIGHT	SHEET 1 of 9	

2

1

**Metal Framing Detail**

Item	Description
A, B	2"x2" Vertical Stud
B, D	2"x2" Air Vent Frame
C	2"x2" Horizontal Stud
C	2"x2" Base Frame

B

B

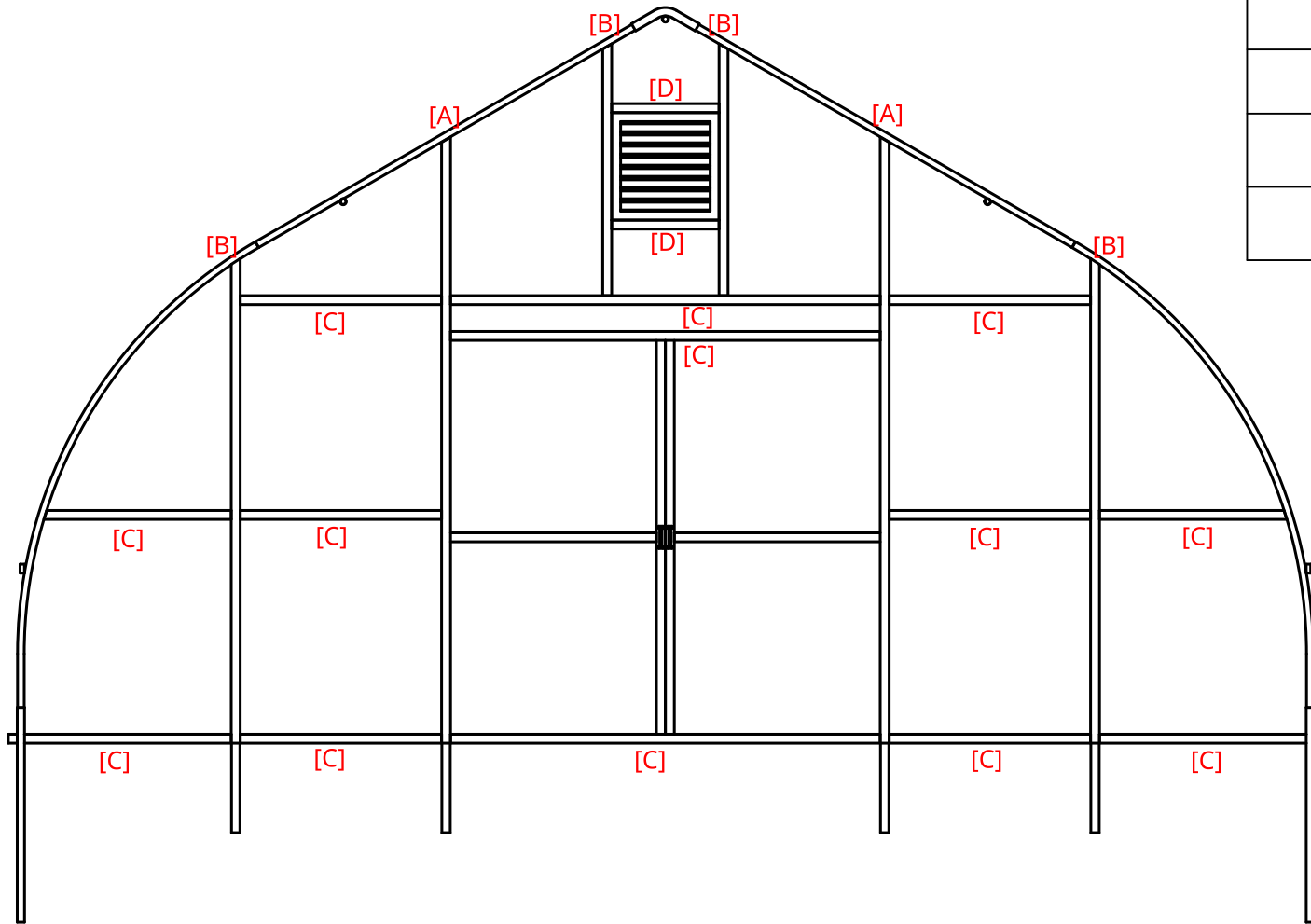

A

A

Wind Load - 65 MPH  
Snow Load - 30 PSF

UNLESS OTHERWISE SPECIFIED,  
DIMENSIONS ARE IN INCHES

.X = ±0.1

BREAK ALL SHARP EDGES AND  
REMOVE BURRS

THIRD ANGLE PROJECTION

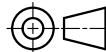

	NAME	DATE
DRAWN	Rica Abing	08/29/2024
CHECKED	Kevin Roberts	
APPROVED		
MATERIAL	FINISH	

Roberts Ranch Hoophouses

TITLE  
24' Wide Gothic Hightunnel  
Front View

SIZE	DWG NO.	REV.
A	G24-2	A
SCALE 1:40	WEIGHT	SHEET 2 of 9

2

1

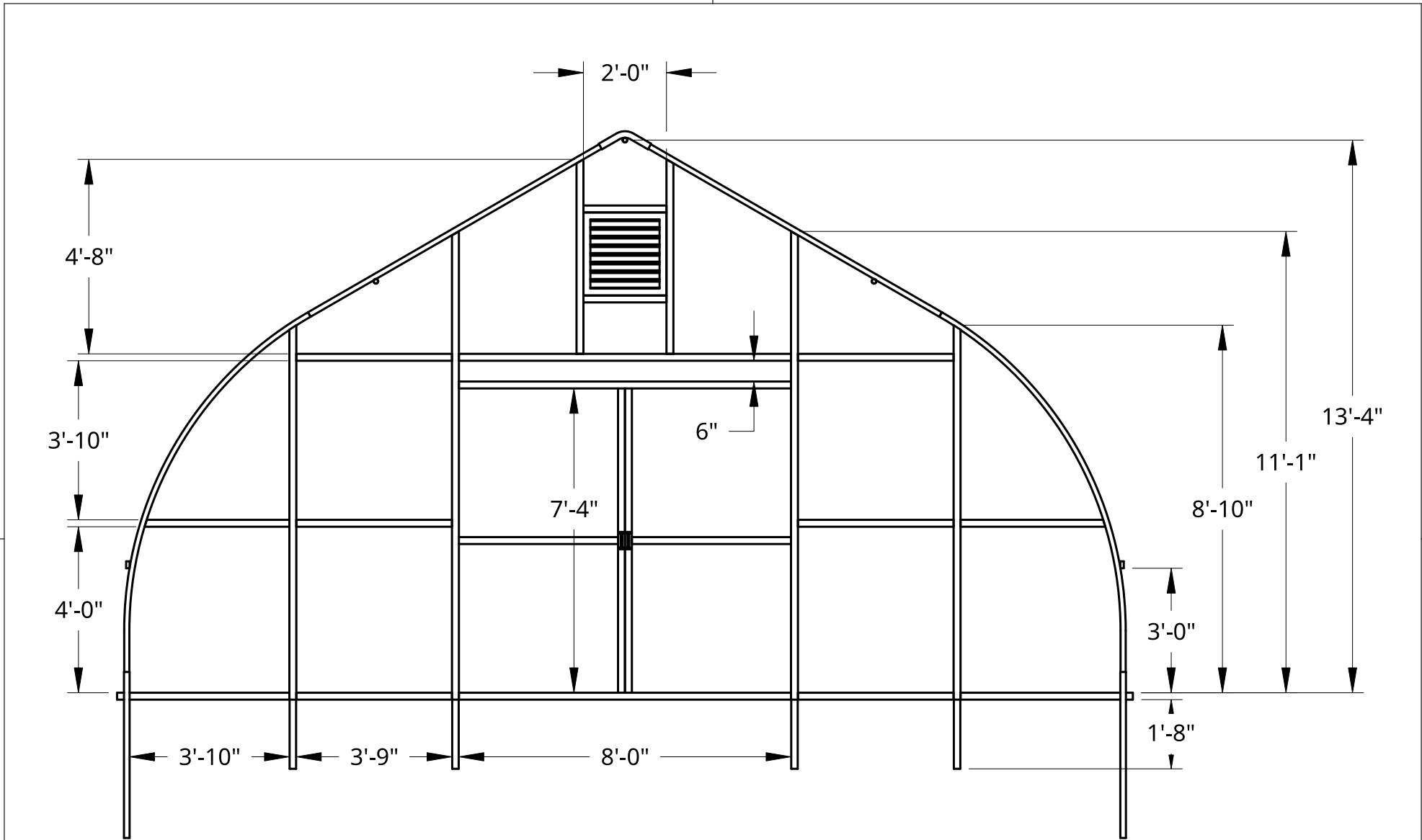

Wind Load - 65 MPH  
 Snow Load - 30 PSF

UNLESS OTHERWISE SPECIFIED, DIMENSIONS ARE IN INCHES		NAME	DATE	Roberts Ranch Hoopouses	
.X = ±0.1	DRAWN	Rica Abing	08/29/2024		
	CHECKED	Kevin Roberts			
	APPROVED				
BREAK ALL SHARP EDGES AND REMOVE BURRS		<b>A</b>		SIZE	DWG. NO.
THIRD ANGLE PROJECTION		MATERIAL	FINISH	<b>A</b>	<b>G24-3</b>
				SCALE	WEIGHT
				1:40	
				SHEET	3 of 9
				REV.	<b>A</b>

2

1

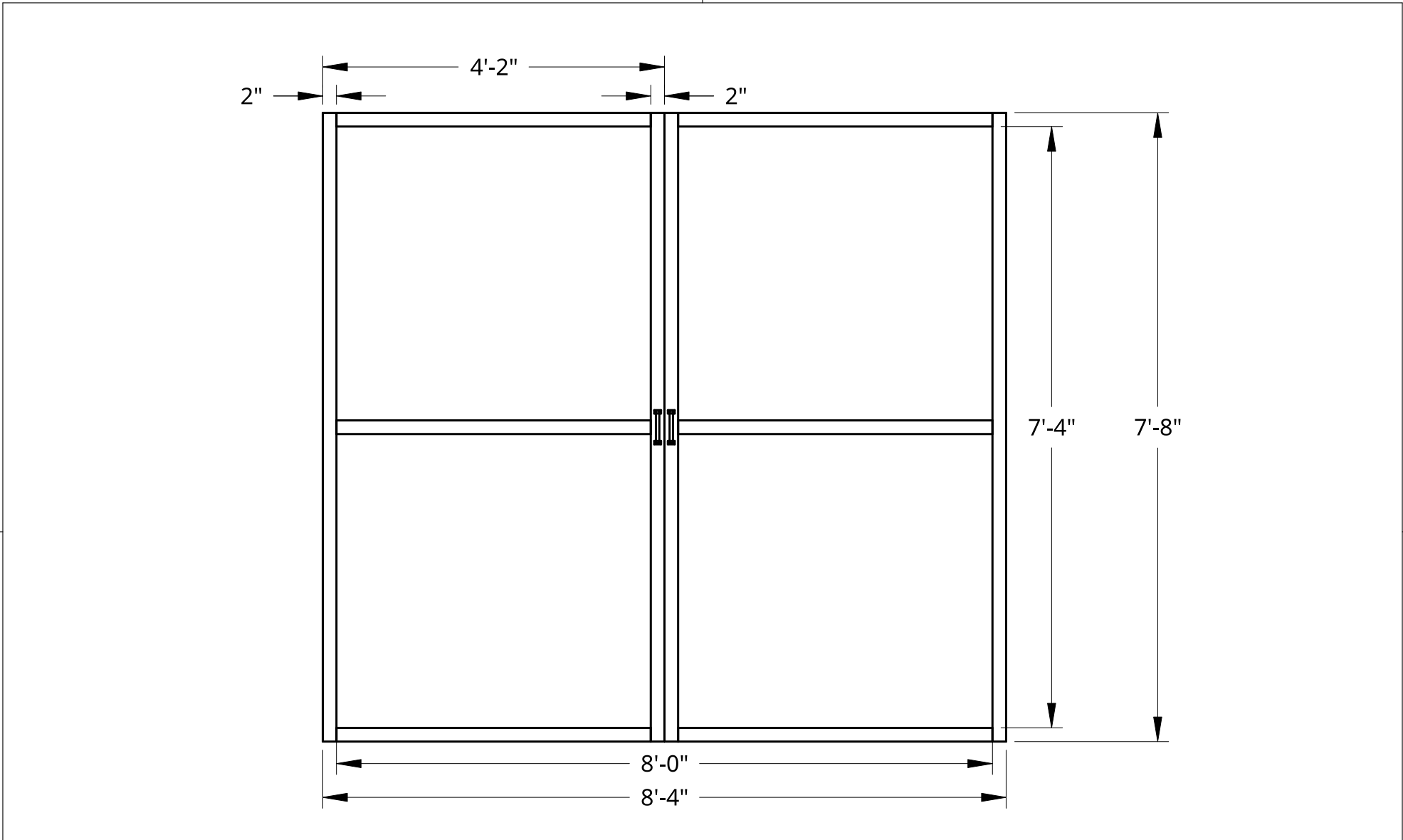

Wind Load - 65 MPH  
 Snow Load - 30 PSF

UNLESS OTHERWISE SPECIFIED, DIMENSIONS ARE IN INCHES .XX = ±.0- .XXX = ±.00- .XXXX = ±.000- SURFACE FINISH		NAME	DATE	Roberts Ranch Hoophouses	
	DRAWN	Rica Abing	08/07/2024		
	CHECKED	Kevin Roberts			
	APPROVED				
DO NOT SCALE DRAWING				SIZE	A
BREAK ALL SHARP EDGES AND REMOVE BURRS				DWG NO.	G24-4
THIRD ANGLE PROJECTION 	MATERIAL	FINISH		SCALE	1:20
	Galvanized Steel			WEIGHT	
				4 of 9	

2

1

B

B

A

A

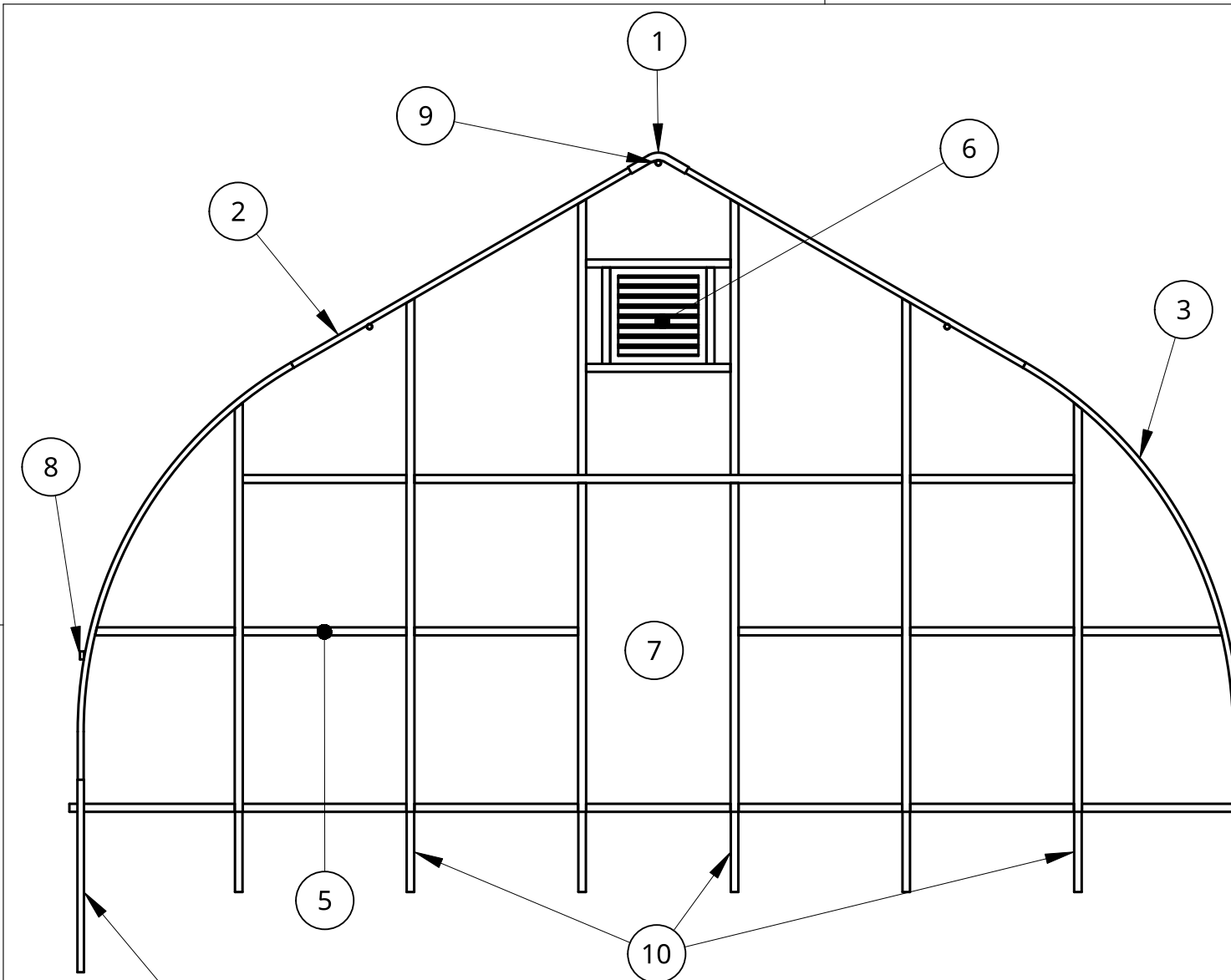

BOM	
Item	Description
1	1.875" OD Peak
2	1.625" OD Truss
3	1.625" OD Arc
4	1.625" OD Post
5	2" x 2" Metal Framing
6	2'x2' Hot Air Vent
7	36"x80" Man Door
8	1"x2" Roll-Up Board
9	1.375" OD Purlin
10	1.875" OD Swedge Post

Wind Load - 65 MPH  
 Snow Load - 30 PSF

UNLESS OTHERWISE SPECIFIED, DIMENSIONS ARE IN INCHES  X = ±0.1	DRAWN	Rica Abing	08/29/2024
	CHECKED	Kevin Roberts	
	APPROVED		
	THIRD ANGLE PROJECTION		
MATERIAL		FINISH	

Roberts Ranch Hoophouses			
TITLE 24' Wide Gothic Hightunnel Back View			
SIZE A	DWG NO. G24-5	REV. A	
SCALE 1:40	WEIGHT	SHEET 5 of 9	

B

B

A

A

2

1

2

1

2

1

### Metal Framing Detail

Item	Description
A, B, C	2"x2" Vertical Stud
B	2"x2" Horizontal Stud
B	2"x2" Base Frame
D	2"x2" Air Vent Frame

B

B

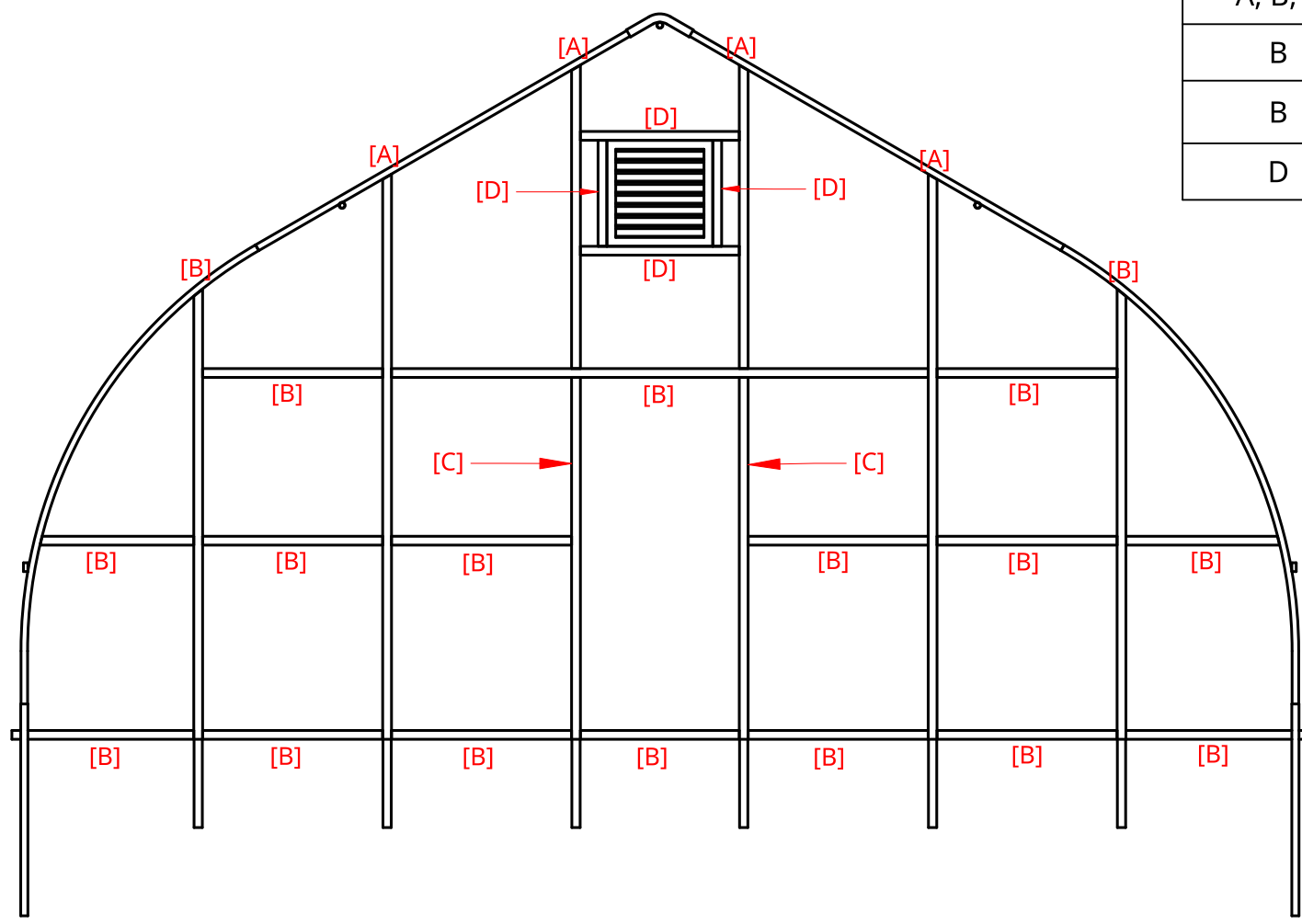

A

A

Wind Load - 65 MPH  
 Snow Load - 30 PSF

UNLESS OTHERWISE SPECIFIED,  
 DIMENSIONS ARE IN INCHES

.X = ±0.1

BREAK ALL SHARP EDGES AND  
 REMOVE BURRS

THIRD ANGLE PROJECTION

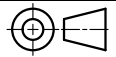

	NAME	DATE
DRAWN	Rica Abing	08/29/2024
CHECKED	Kevin Roberts	
APPROVED		
MATERIAL	FINISH	

Roberts Ranch Hoophouses

24' Wide Gothic Hightunnel  
 Back View

SIZE	DWG NO.	REV.
A	G24-6	A
SCALE	WEIGHT	SHEET
1:40		6 of 9

2

1

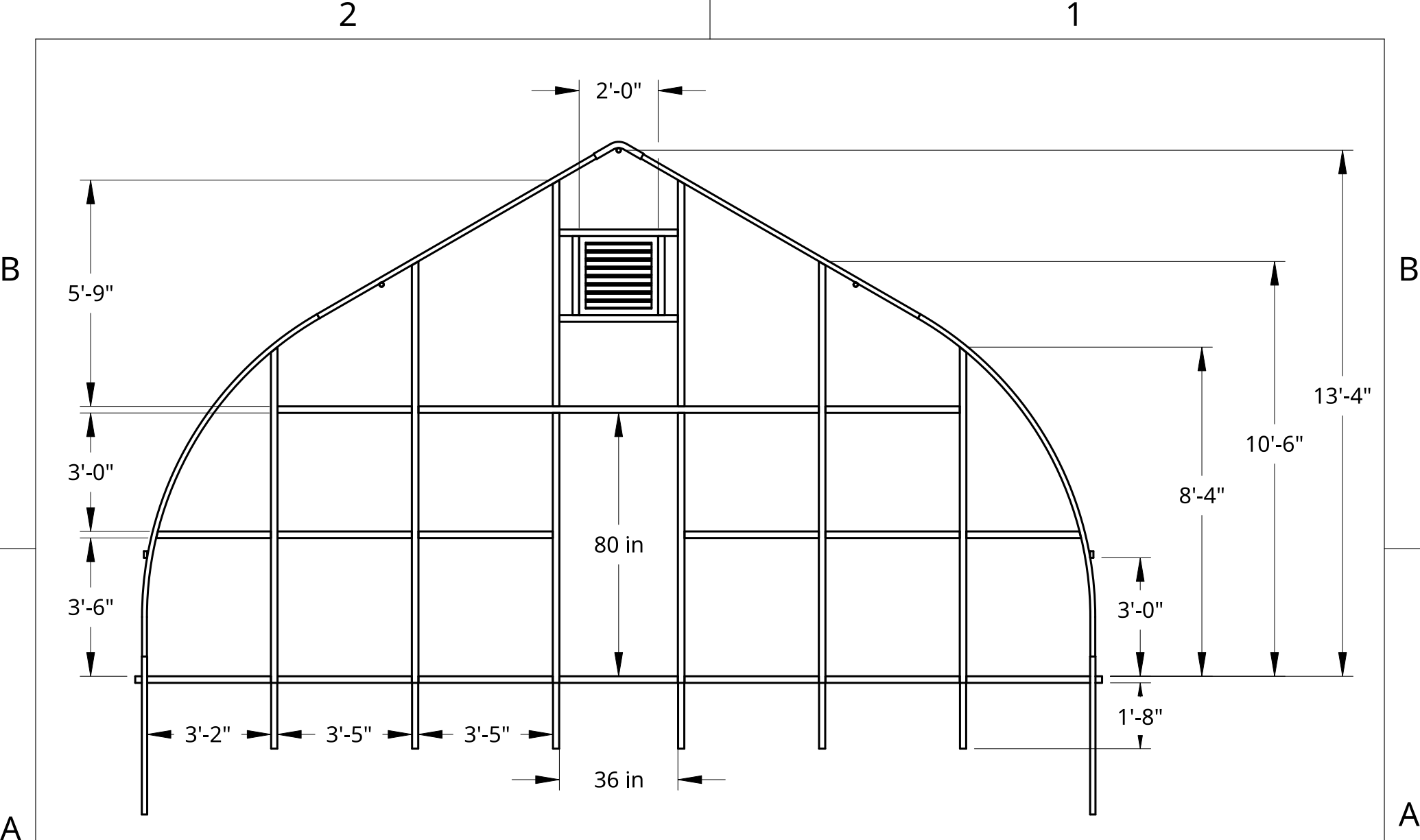

Wind Load - 65 MPH  
 Snow Load - 30 PSF

UNLESS OTHERWISE SPECIFIED, DIMENSIONS ARE IN INCHES		NAME	DATE	Roberts Ranch Hoophouses		
.X = ±0.1	DRAWN	Rica Abing	08/29/2024			TITLE 24' Wide Gothic Hightunnel Dimensioned Back View
	CHECKED	Kevin Roberts				
	APPROVED					
BREAK ALL SHARP EDGES AND REMOVE BURRS				SIZE	DWG. NO.	REV.
THIRD ANGLE PROJECTION		MATERIAL	FINISH	A	G24-7	A
				SCALE	WEIGHT	SHEET
				1:40		7 of 9

2

1

B

B

A

A

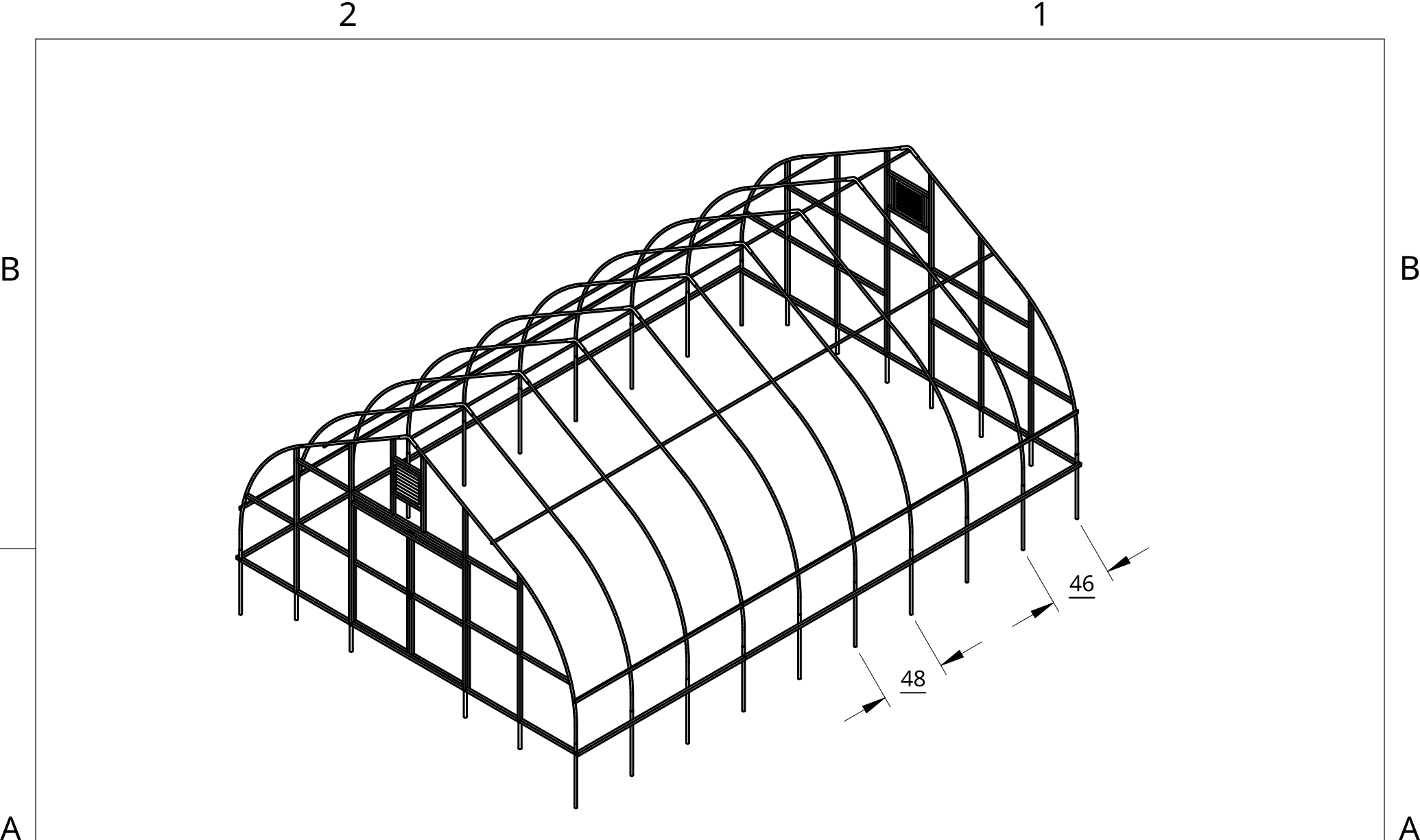

Wind Load - 65 MPH  
 Snow Load - 30 PSF

UNLESS OTHERWISE SPECIFIED, DIMENSIONS ARE IN INCHES		NAME	DATE	Roberts Ranch Hoophouses		
.X = ±0.1	DRAWN	Rica Abing	08/29/2024			TITLE 24' Wide Gothic Hightunnel Isometric View
	CHECKED	Kevin Roberts				
	APPROVED					
BREAK ALL SHARP EDGES AND REMOVE BURRS				SIZE	DWG NO.	REV.
THIRD ANGLE PROJECTION		MATERIAL	FINISH	A	G24-8	A
				SCALE	WEIGHT	SHEET
				1:80		8 of 9

2

1



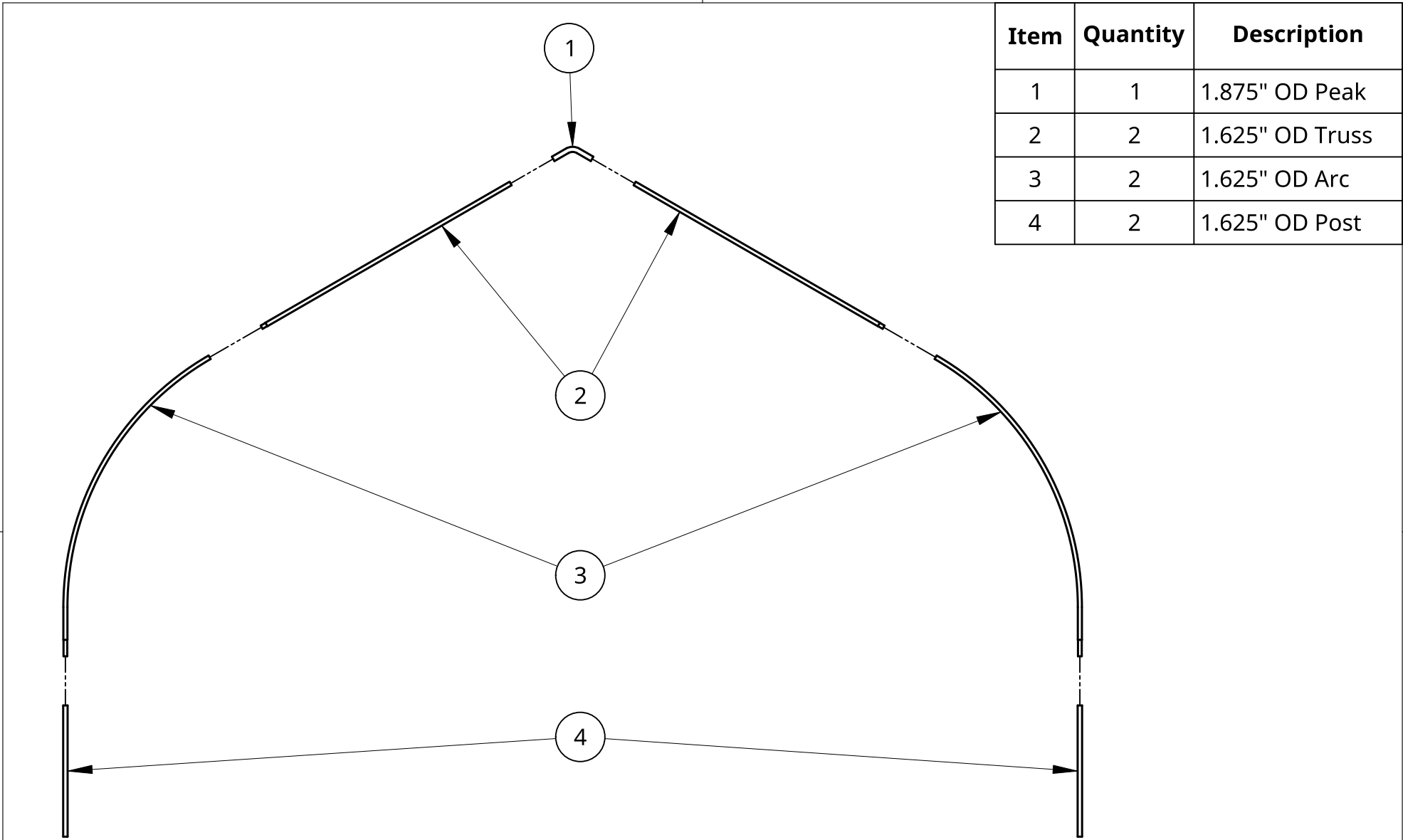

Item	Quantity	Description
1	1	1.875" OD Peak
2	2	1.625" OD Truss
3	2	1.625" OD Arc
4	2	1.625" OD Post

Wind Load - 65 MPH  
Snow Load - 30 PSF

UNLESS OTHERWISE SPECIFIED,  
DIMENSIONS ARE IN INCHES

.XX = ±.0-  
.XXX = ±.00-  
.XXXX = ±.000-

ANGULAR = ± °  
FRACTIONAL = ±

SURFACE FINISH

DO NOT SCALE DRAWING

BREAK ALL SHARP EDGES AND  
REMOVE BURRS

THIRD ANGLE PROJECTION

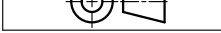

	NAME	DATE
DRAWN	Rica Abing	08/08/2024
CHECKED	Kevin Roberts	
APPROVED		
MATERIAL	Galvanized Steel	FINISH

Roberts Ranch Hoopouses		
TITLE 24' Wide Gothic Hightunnel Arch Exploded View		
SIZE <b>A</b>	DWG NO. <b>G24-9</b>	<b>C</b>
SCALE 1:50	WEIGHT	9 of 9